

Globe Valves

Type 01341 - Globe Valve



Cryogenic-Globe and Globe/Check Valves, PN50 (DN150=PN40)

Stainless steel body and topwork,
 "live loaded" gland packing
 "cleaned and degreased for oxygen service"

Part No. 01341.X.001* (H = 270mm)

Part No. 01341.X.002* (H = 370mm)

Part No. 01341.X.501* (H = 270mm) Globe/Check Valve

Part No. 01341.X.502* (H = 370mm) Globe/Check Valve

*Butt weld connection for stainless steel pipes acc. to ISO 1127 or ASTM A312

Part No. 01341.X.0014 (H = 270mm)

Part No. 01341.X.0024 (H = 370mm)

Part No. 01341.X.5014 (H = 270mm) Globe/Check Valve

Part No. 01341.X.5024 (H = 370mm) Globe/Check Valve

Socket weld connection for stainless steel pipes acc. to ISO 1127 or ASTM A312

Available options - on request only:

- Welded stainless steel stubs acc. to ISO 1127 or ASTM A312 - length FF + 200mm
- Extension H up to 900mm
- Valve with control disc (tapered design)
- Further pipe wall thicknesses

Applications:

Approved for air gases, vapours and cryogenic liquefied gases incl. LNG.

Working temperature: -196°C / -321°F (77K) up to +120°C / +248°F (393K)



Materials	DIN EN	ASTM
1 Body	1.4308	A 351 CF8
2 Valve seal up to DN50	PTFE / Carbon filled (25%)	
2a Valve seal from DN65	PTFE	
3 Disc	1.4301	A 276 Grade 304
4 Bonnet gasket	PTFE	
5 Headpiece	1.4301 / 1.4308	A 276 Grade 304 / A 351 CF8
6 Bolts	1.4301/A2	A 194 B8
7 Elongation tube	1.4541	A 213 TP 321
8 Stem	1.4301	A 276 Grade 304
9 Gland packing	Graphite / PTFE	
10 Gland nut	1.4305	A 276 Grade 303
11 Handwheel	Aluminium alloy	
12 Spring	1.4310	A 313 Grade 301
13 Bush	CW452K	B 159 UNS C51900

Standard marking acc. to Pressure Equipment Directive 2014/68/EU (PED).

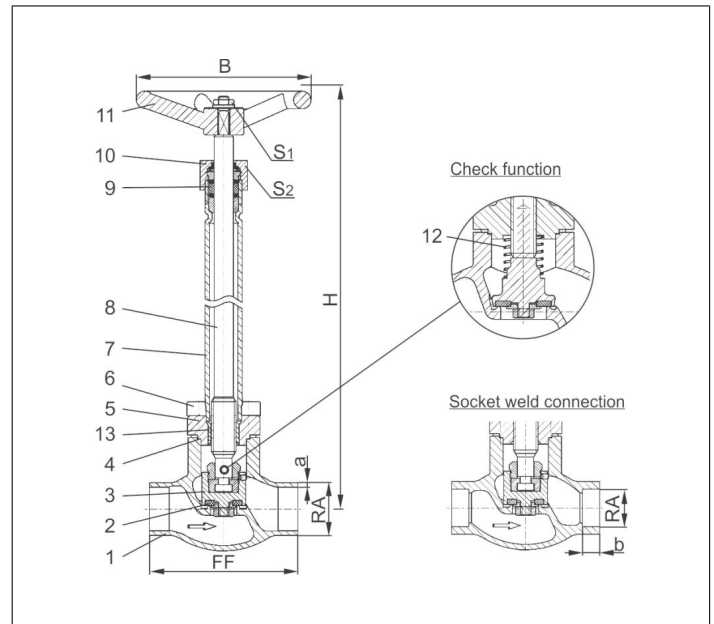

Type 01341 - Standard design	Technical data	Nominal size													
		DN	10	15	15	20	25	32	40	40	50	65	80	100	150
Dimension code	.X.	1012	1517	1521	2026	2533	3238	4042	4048	5060	657x	8088	0114	0168	
Face-to-face dimension	FF	70	85	85	100	115	115	130	130	155	205	245	280	400	
Height	H	270mm or 370mm												370	420
Outside pipe-Ø ISO 1127	RA	12.0	17.2	21.3	26.9	33.7	38.0	42.4	48.3	60.3	76.1	88.9	114.3	168.3	
Wall thickness pipe ISO 1127	a	1.0	1.6	2.0	2.0	2.0	2.0	2.0	2.0	2.0	2.6	3.2	6.0	7.1	
Outside pipe-Ø ASTM A312	RA	13.72	17.15	21.34	26.67	33.40	-	42.16	48.26	60.33	73.03	88.90	114.3	168.3	
Wall thickness pipe ASTM A312	a	dimensions acc. to S10 or S40													
Socket depth	b	6	10	10	13	13	-	13	13	16	16	16	20	20	
Handwheel-Ø	B	100	100	100	100	100	125	125	125	125	200	250	315	360	
Wrench size across flats	S ₁	10	10	10	10	10	13	13	13	13	13	13	13	19	
Wrench size across flats	S ₂	30	30	30	30	30	36	36	36	36	36	36	41	41	
Weight	ca. kg	1.4	1.65	1.7	2.1	2.4	3.3	4.7	4.7	7.2	12.7	17.0	24.5	54.0	
Kvs-Value	m ³ /h	1.6	3.8	4.3	6.7	11.5	14.0	20.6	22.6	37.1	71.1	104.0	170.0	350.0	
Cv-Value	gal/min	1.9	4.4	5.0	7.8	13.4	16.2	23.9	26.3	43.2	82.7	120.9	195.2	401.8	

Dimensions in mm. Compliance of tightness requirements acc. to EN 1626 for DN150 up to 20 bar differential pressure. In the range of >20-40 bar, 350-700ml (1 bar, 20°C [68°F]) are reached.